



Quality Tools for Smart Cleaning



**RO M**  
**(R035C)**



**READ THE OPERATING INSTRUCTIONS BEFORE SWITCHING ON THE SYSTEM!**

**KEEP IT IN THE IMMEDIATE VICINITY OF THE MACHINE AT ALL TIMES!**

Original operating instructions

# OPERATING INSTRUCTIONS

|          |   |           |
|----------|---|-----------|
| <b>1</b> | <b>Introduction.....</b>                          | <b>4</b>  |
| 1.1      | General information.....                          | 4         |
| 1.2      | Intellectual and industrial property rights ..... | 4         |
| 1.3      | Property and legal deficiencies .....             | 4         |
| 1.4      | Explanation of signs.....                         | 5         |
| 1.4.1    | Instructions for use.....                         | 5         |
| 1.4.2    | Enumerations .....                                | 5         |
| 1.4.3    | Hazard classes .....                              | 6         |
| 1.4.4    | Warning signs.....                                | 7         |
| 1.4.5    | Mandatory signs .....                             | 7         |
| 1.5      | Nameplate.....                                    | 8         |
| 1.6      | Obligation of the operator .....                  | 8         |
| 1.7      | Obligation of personnel.....                      | 8         |
| 1.7.1    | Requirements for staff .....                      | 8         |
| 1.7.2    | Training of staff .....                           | 9         |
| 1.8      | Storing the operating instructions .....          | 9         |
| 1.9      | Contact addresses .....                           | 9         |
| <b>2</b> | <b>About HydroPower RO .....</b>                  | <b>10</b> |
| 2.1      | Using the HydroPower RO .....                     | 10        |
| 2.1.1    | Intended use.....                                 | 10        |
| 2.1.2    | Foreseeable misuse .....                          | 10        |
| 2.2      | Technical specifications.....                     | 10        |
| 2.2.1    | Operating conditions .....                        | 10        |
| 2.2.2    | Electrical specifications .....                   | 10        |
| 2.2.3    | Protection types of electrical components .....   | 10        |
| 2.2.4    | Pressure ratings.....                             | 11        |
| 2.2.5    | Dimensions quick overview .....                   | 11        |
| 2.2.6    | Media connections .....                           | 11        |
| 2.2.7    | Water quality .....                               | 11        |
| 2.2.8    | Water output quantity.....                        | 11        |
| 2.3      | Scope of delivery .....                           | 11        |
| <b>3</b> | <b>Safety .....</b>                               | <b>12</b> |
| 3.1      | General safety regulations.....                   | 12        |
| 3.1.1    | Basic principles.....                             | 12        |
| 3.1.2    | Unit protection and warning processes .....       | 12        |
| 3.2      | Mechanical hazards .....                          | 13        |
| 3.3      | Electrical hazards .....                          | 13        |
| 3.4      | Thermal hazards.....                              | 13        |
| 3.5      | Hazards due to pressure.....                      | 13        |
| 3.6      | Hazards from materials and substances .....       | 14        |

# Content

|          |   |           |
|----------|---|-----------|
| <b>4</b> | <b>Preparing for use .....</b>                                    | <b>15</b> |
| 4.1      | Construction of the HydroPower RO.....                            | 15        |
| 4.2      | Interfaces .....  | 15        |
| 4.3      | Transport and storage .....                                       | 16        |
| 4.3.1    | Transportation .....  | 16        |
| 4.3.2    | Storage .....   | 17        |
| 4.3.3    | Operation the HydroPower RO.....                                  | 17        |
| 4.4      | Commissioning .....   | 18        |
| <b>5</b> | <b>Operation of the HydroPower RO .....</b>                       | <b>20</b> |
| 5.1      | General information.....  | 20        |
| 5.2      | Cleaning surfaces with the HydroPower RO / Normal operation ..... | 21        |
| 5.3      | Interruption of work.....   | 21        |
| 5.4      | Switching off the HydroPower RO.....                              | 21        |
| <b>6</b> | <b>Malfunctions.....</b>  | <b>22</b> |
| 6.1      | Procedure for accidents.....                                      | 22        |
| 6.2      | Procedure for malfunctions.....                                   | 22        |
| <b>7</b> | <b>Maintenance and servicing .....</b>                            | <b>24</b> |
| 7.1      | General information.....  | 24        |
| 7.2      | Maintenance and maintenance plan .....                            | 25        |
| 7.2.1    | Daily inspection .....  | 25        |
| 7.2.2    | Quarterly examination.....  | 25        |
| 7.2.3    | Monthly examination .....   | 25        |
| 7.2.4    | Membrane protection.....  | 26        |
| 7.3      | Repair and replacement of parts.....                              | 27        |
| 7.3.1    | Replacing filter cartridges .....                                 | 27        |
| <b>8</b> | <b>Switching off the device.....</b>                              | <b>29</b> |
| 8.1      | Disassembly and storage.....                                      | 29        |
| 8.2      | Recycling.....  | 30        |
| 8.3      | Disposal of waste .....   | 30        |
|          | <b>Proofreading documents .....</b>                               | <b>32</b> |
|          | EC Declaration of Conformity .....                                | 32        |

## **1 Introduction**

### **1.1 General information**

This manual allows you to use the HydroPower RO safely and efficiently.

The operating instructions are part of the HydroPower RO and must be kept accessible to the personnel in the immediate vicinity of the HydroPower RO at all times.

Before starting work, the personnel must have read and understood this manual. All safety instructions and instructions for use stated in this manual must be followed for safe operation.

The current version of the HydroPower RO is described in this manual. If changes or additions become necessary over time, the operating instructions will be accompanied by a supplement which will be incorporated into the next revision.

The respective revision status of the operating instructions is displayed on the cover sheet. The first user manual has the revision status „1.0“. The status is increased by „1“ for each revision.

### **1.2 Intellectual and industrial property rights**

All contents of this manual are the intellectual property of Unger Germany GmbH and are protected by copyright law.

The product, as well as the word / image mark, are legally protected.

Any duplication, processing, distribution or transfer to third parties - including, but not limited to - any kind of exploitation outside of the copyright limits require the written consent of Unger Germany GmbH.

In the case of infringements, Unger Germany GmbH reserves the right to take legal action at any time.

We reserve the right to make changes to this manual, as well as changes to technical details, with regard to the specifications and illustrations in this manual.

### **1.3 Property and legal deficiencies**

Claims for material and legal deficiencies presuppose that the operator shall submit the defect in writing without delay, but at the latest within two working days.

Unger Germany GmbH is in no case responsible for damage to the system itself, or damage caused by the unit due to improper handling of the product.

In particular, Unger Germany GmbH is not responsible for failures or errors caused by modifications to the unit by the customer or other persons.

If Unger Germany GmbH is responsible for a defect, Unger Germany GmbH shall repair or replace the unit at its discretion.

Claims for material and legal deficiencies will be nullified in the case of non-compliance with the individual regulations of this manual, the relevant legal provisions, as well as further recommendations given by Unger Germany GmbH.

# Explanation of signs

## 1.4 Explanation of signs

### 1.4.1 Instructions for use

Instructions for use are shown as follows:

To perform an action, proceed as follows:

1. Do this.
2. Do that.
- ▶ This is the intermediate result.
3. Do that.
- ✓ You have completed the action.

### 1.4.2 Enumerations

Enumerations are shown as follows:

- List of first order,
  - Second order,
  - Second order,
- List of first order.

### 1.4.3 Hazard classes

Safety instructions are shown in this manual with standardized illustrations and symbols. Depending on the probability of the occurrence and severity of the consequence, the following hazard classes are used:

 **DANGER**



**Indicates a hazardous situation that can lead to serious injury or death.**

- ▶ Here you will find measures to avoid the danger.

 **CAUTION**



**Indicates a potentially hazardous situation, which can lead to minor injuries.**

- ▶ Here you will find measures to avoid the danger.

**ATTENTION**

**Indicates a situation which can lead to material damage.**

- ▶ Here you will find measures to prevent material damage.

**NOTE**



Here you can find application tips and other useful information.

# Explanation of signs

## 1.4.4 Warning signs



Warning of a hazard.

---



Warning of electrical voltage.

---



Warning of overpressure in containers.

---



Warning of hot surfaces.

---



Warning of suspended loads.

---



Warning of injury to the limbs.

---

## 1.4.5 Mandatory signs



Application tips and other useful information.

---



Use protective gloves.

---



Use safety shoes.

---



Use protective goggles.

---

## 1.5 Nameplate

Each HydroPower RO from Unger Germany GmbH has a nameplate on the side.

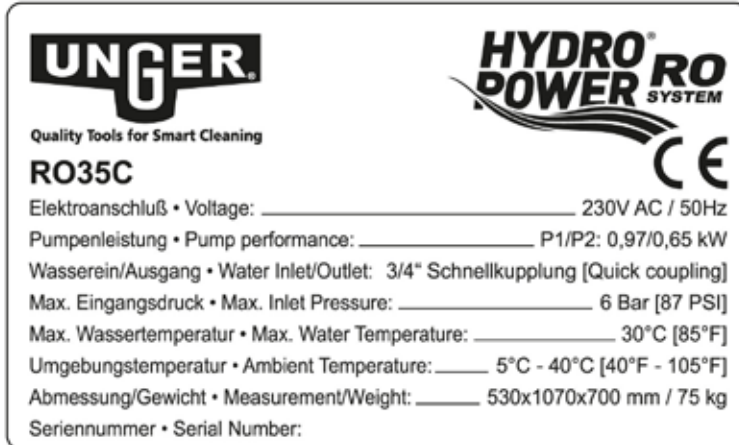

Pic. 1 *Nameplate*

## 1.6 Obligation of the operator

The HydroPower RO is used in the commercial sector. The operator must adhere to the statutory obligations to work safety.

The operator is obliged to have only persons working on the HydroPower RO that:

- are familiar with the basic regulations on work safety and accident prevention
- have been trained in the handling of the HydroPower RO
- have read and understood the safety instructions and safety regulations in this manual

The operator is obligated to ensure that all warnings on the HydroPower RO are always legible.

## 1.7 Obligation of personnel

Working with the HydroPower RO is only permitted if the operating instructions have been read and understood.

### 1.7.1 Requirements for staff

Only persons who perform their work reliably, should be authorized as personnel for this unit. Persons whose reactions and judgement are affected, e.g. by drugs, alcohol or medication, are NOT permitted to operate this unit.

#### NOTE



The operator is recommended to have this confirmed in writing.



# Obligations

## 1.8.2 Training for staff

These operating instructions are aimed at staff with the following professional qualifications:

The staff will be able to carry out the tasks assigned to them and to recognize and avoid possible dangers independently on the basis of their professional training, experience and knowledge, as well as the knowledge of relevant provisions.

## 1.9 Storing the operating instructions

This instruction manual must be kept in the immediate vicinity of the HydroPower RO and must be available to the entire staff at all times. The operator must inform the personnel about the location of these operating instructions.

If the user manual has become illegible due to constant use, the operator must obtain replacement from the manufacturer.

These operating instructions can also be downloaded as a PDF at [www.ungerglobal.com/downloads](http://www.ungerglobal.com/downloads).

### NOTE



When transferring or reselling the HydroPower RO to third parties, the following documents must be passed on to the new owner:

- ▶ this manual,
- ▶ the documentation of the repair work,
- ▶ proof of maintenance work.

## 1.10 Contact address

Unger Germany GmbH

Piepersberg 44  
42653 Solingen  
Germany

Telefon: (49) 0212 / 22 07-0

Fax: (49) 0212 / 22 07-2 22

[service@ungerglobal.com](mailto:service@ungerglobal.com)

[www.ungerglobal.com](http://www.ungerglobal.com)

## 2 About HydroPower RO

### 2.1 Usage of HydroPower RO

#### 2.1.1 Intended use

The HydroPower RO is used for the filtration of drinking water by demineralisation for the purpose of glass and surface cleaning.

The HydroPower RO is intended for commercial use only.

The HydroPower RO may only be connected to drinking water lines.

#### 2.1.2 Foreseeable misuse

The use of the HydroPower RO in any way other than described in the chapter „2.1.1 Intended use“ is considered to be non-compliant and thus unlawful.

This applies in particular to the use of the HydroPower RO for bacteria removal.

### 2.2 Technical specifications

#### 2.2.1 Operating conditions

|                          |          |
|--------------------------|----------|
| Ambient temperature [°C] | 5 ... 40 |
| Water temperature [°C]   | 5 ... 30 |

#### ATTENTION

##### Material damage due to improper handling.

Ensure that the incoming water corresponds to the national drinking water regulations.

The drinking water must be free of iron, manganese and heavy metals (max. 0.2 ml / l iron, 0.05 mg / l manganese), the maximum silicate (SiO<sub>2</sub>) content must not exceed 20 mg / l. It must also not contain barium and strontium.

#### 2.2.2 Electrical specifications

|  |          |
|--|----------|
| Primary electrical connection [V / Hz] | 230 / 50 |
| Power consumption                      | 0,97 kW  |

#### 2.2.3 Protection types of electrical components

|                |       |
|----------------|-------|
| Electric motor | IP 54 |
|----------------|-------|

# Technical specifications

## 2.2.4 Pressure ratings

|                               |        |
|-------------------------------|--------|
| Input pressure [bar]          | 1... 6 |
| Max. operating pressure [bar] | 10     |

## 2.2.5 Dimensions quick overview

|                   |       |
|-------------------|-------|
| Height [mm]       | 1070  |
| Width [mm]        | 530   |
| Depth [mm]        | 700   |
| Empty weight [kg] | 72 kg |

## 2.2.6 Media connections

|  |        |
|--|--------|
| Standard feedwater connection thread ["]   | 3/4    |
| Standard concentrate connection thread ["] | 3/4    |
| Standard permeate connection thread ["]    | 2x 3/4 |

## 2.2.7 Water quality

|   |      |
|---|------|
| Max. salt content in incoming water [ppm]         | 1000 |
| SiO <sub>2</sub> content in incoming water [mg/l] | 20   |

## 2.2.8 Water output quantity

The water flow depends on factors like water temperature, hose length and hose diameter.

### Measuring Setup:

- Hose length: each 25m
- 3 different hose diameters: 5mm / 7mm / 1/2"
- 3 different water temperatures: 8 / 13 / 20°C
- Line pressure: 4 bar

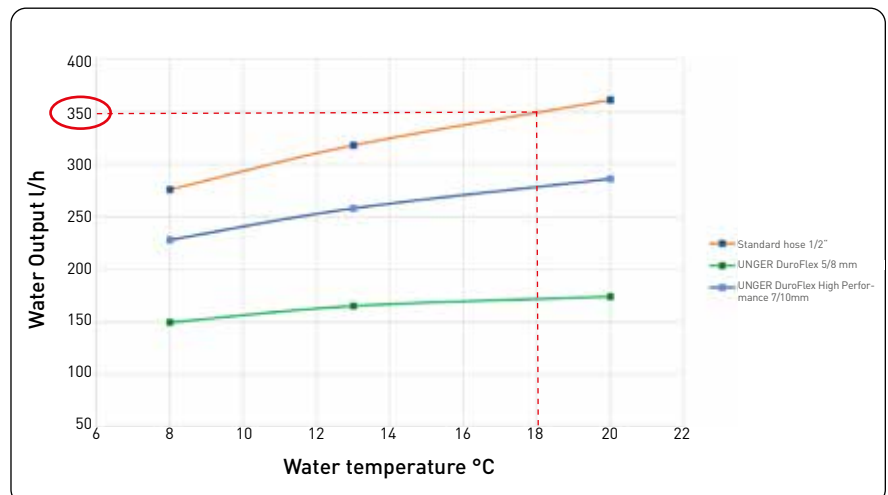

## 2.3 Scope of delivery

The following is included in each delivery:

- HydroPower RO
- Concentrate hose
- Instruction manual
- Test report

## 3 Safety

### 3.1 General safety regulations

#### 3.1.1 Basic principles

Special safety regulations may apply to certain activities. Safety instructions and warnings are given in the respective sections of the operating instructions.

Operate the HydroPower RO only:

- in accordance with the operating instructions for safety and driving safety
- if the HydroPower RO is in a technically sound condition.

This includes:

- The safety stickers attached to the HydroPower RO must always be complete and in good readable condition. Renew damaged or unreadable signs.
- Carry out cleaning and maintenance work on the HydroPower RO only if it is disconnected from electricity.  
Turn off the main power switch and unplug the power cord.
- Carry out maintenance on the filter vessels only if they are depressurized.
- Clean the HydroPower RO after use of dirt and impurities.



**Use personal protective equipment to avoid personal injury:**

- ▶ protective gloves,



- ▶ safety shoes,



- ▶ safety goggles.

#### 3.1.2 Unit protection and warning processes

##### Overheat protection

If the pump overheats, the overheat protection is triggered automatically and the HydroPower RO switches off.

##### Pressure relief valve

If the water pressure in the HydroPower RO is too high (above 10.5 bar), the pressure relief valve opens at the back of the HydroPower RO and releases excess water through the concentrate hose to reduce the pressure in the system.

# General safety regulations

## 3.2 Mechanical hazards



### Crushing due to incorrect operation and / or carelessness.

- ▶ Do not reach between the ground surface and the HydroPower RO.
- ▶ Do not place objects in the openings of the HydroPower RO.



- ▶ Place the HydroPower RO on an even surface only.
- ▶ Ensure sufficient stability and secure the HydroPower RO against tipping over or rolling away.
- ▶ In the case of faults and emergencies, immediately turn off the unit by pressing the STOP button on the main switch of the HydroPower RO.
- ▶ Wear safety shoes.

## 3.3 Electrical hazards



### Electric shock and burns due to live parts.

- ▶ Before each use, perform a visual inspection of the power cable for damage. If you notice any damage, contact your distributor.
- ▶ Maintenance on the electrical components of the system may only be carried out by employees of Unger Germany GmbH or their authorized specialist dealers / technicians.

## 3.4 Thermal hazards



### Burns due to hot surfaces.

- ▶ The housing of the pump motor can become hot during operation. Allow the system to cool down sufficiently before touching components marked with this symbol.



Wear protective gloves.

## 3.5 Hazards due to pressure



### Injuries from pressurized containers.

- ▶ The 4 filter vessels are pressurized during operation.
- ▶ Never open a filter vessel during operation.
- ▶ Bleed the air out of the HydroPower RO before opening and during initialization by pushing the two yellow buttons on the lids of the front two vessels.

## 3.6 Hazards from materials and substances

The safety data sheets of the materials and substances can be found online at [www.ungerglobal.com/downloads-safety-data-sheets](http://www.ungerglobal.com/downloads-safety-data-sheets).



### Irritation to the eyes, skin and respiratory tract through carelessness.



- ▶ Avoid any contact with the resin when replacing the DI resin cartridge.
- ▶ In case of contact with eyes, remove contact lenses and rinse immediately with plenty of water.



- ▶ Wash hands after finishing work.
- ▶ Use protective gloves and goggles.



### Irreversible injury due to slipping.



- ▶ If resin is spilled, carefully clean it up immediately as there is a high risk of slipping.
- ▶ Wear safety shoes.



### Irritation to eyes, skin and respiratory tract through membrane care.



- ▶ Avoid any contact and swallowing of the membrane care liquid (sold separately).
- ▶ In case of contact with eyes, remove contact lenses and rinse immediately with plenty of water.



- ▶ Keep the membrane care liquid sealed and inaccessible to children.
- ▶ Use protective gloves and goggles.

# System overview

## 4 Preparing for use

### 4.1 Construction of the HydroPower RO

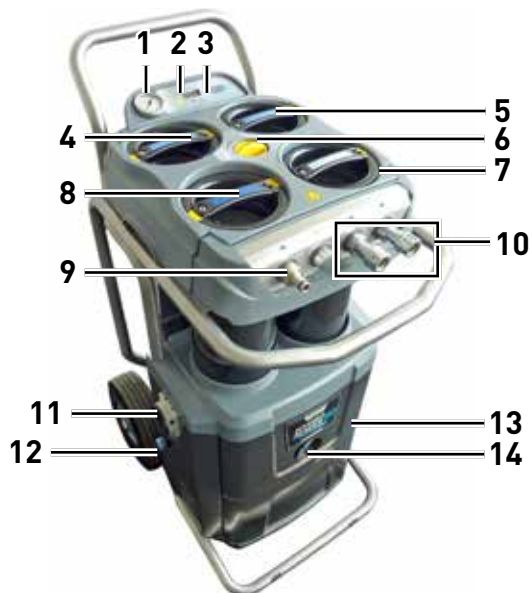

- 1 Manometer
- 2 TDS-Meter On
- 3 TDS-Meter Display
- 4 RO-Membrane 1
- 5 RO-Membrane 2
- 6 Water flow controller
- 7 DI resin filter
- 8 Carbon/sediment combi pre-filter
- 9 Water inlet
- 10 2 x Water outlet
- 11 Main switch (On / Off)
- 12 Pump Reset
- 13 Pump ventilation slot
- 14 Water meter
- 15 Power cord
- 16 Concentrate output
- 17 Pressure valve  
(with lever for manual draining of water)



ENGLISH

### 4.2 Interfaces



The **TDS meter** shows the water quality behind the RO membranes and behind the DI resin filter. The membranes (RO) should operate at 95-98% efficiency in relation to tap water.

The resin filter (DI) should ideally show a value of 0. At the latest when it shows 10, it should be replaced.



The **water meter** measures the water flow at the inlet (9). This is particularly important for the combination pre-filter, as it must be replaced after approx. 70,000l.



The **manometer** shows the water pressure on the membranes when the pump is running. Ensure that the water pressure is at least 1 bar. The optimum is 4 bar, maximum should not exceed 6 bar. The pump increases the pressure by approx. 4 bar. Accordingly, the pressure in operation should not exceed 10 bar. At a pressure of 10.5 bar, the pressure relief valve opens automatically at the rear.



On the front are 3 connections for attaching hoses for water fed poles and 1 connection for the water supply. These are standard hose connections.

Make sure that water cannot flow back into the tap water line, e.g. through a backflow prevention device.



The water outlet for the concentrate is located at the back. Pour the concentrate down the drain using the enclosed concentrate hose.

### 4.3 Transport and storage

#### 4.3.1 Transport

The HydroPower R0 is delivered on a pallet by a forwarding company.

The HydroPower R0 is carefully tested and packaged before shipment. However, damage during transport cannot be ruled out.

Therefore, immediately check the HydroPower R0 for integrity in the presence of the dealer.

Check the completeness of the delivery, see chapter „2.3 Scope of delivery“.

Carry out a visual inspection of the HydroPower R0 for transport damage.

If the HydroPower R0 has been damaged during transport, show the damage to the company delivering HydroPower R0 on behalf of your dealer.

**Complaints due to transport damage cannot be accepted without written confirmation by the dealer or with unreserved acceptance!**

In the case of transport of the HydroPower R0 for use at height, e.g. on a house roof:



**DANGER**



**Severe injuries and property damage due to the HydroPower R0 falling are possible.**



- ▶ Do not walk or grab under the suspended load.
- ▶ Use only the fixing points provided for fixing the hoist.
- ▶ Only use a suitable hoist.
- ▶ Secure the HydroPower R0 to the transport.
- ▶ Observe the weight and maximum dimensions of the HydroPower R0.
- ▶ Wear protective gloves and safety shoes.



When transporting, ensure that the HydroPower R0 is properly secured and cannot move in the transport. Protect the HydroPower R0 from external damage.

Use the fixing points of the frame during transport, or if the HydroPower R0 is lifted with a crane, in order to avoid damage.



# Operating the HydroPower RO

### 4.3.2 Storage

If the unit is not in use for more than 7 days, the membranes must be protected according to the storage instructions, see chapter „7.2.4 Membrane protection“.

### 4.3.3 Operating the HydroPower RO

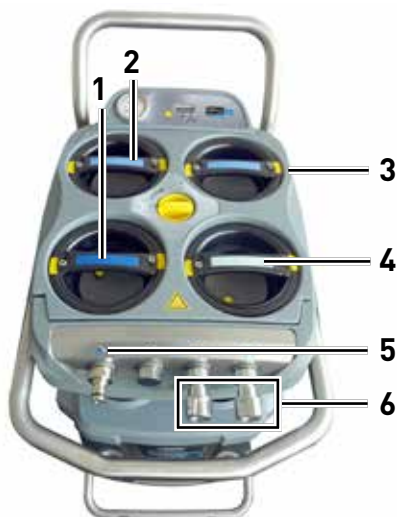

- 1 Carbon/sediment combi pre-filter
- 2 RO membrane 1
- 3 RO membrane 2
- 4 DI resin filter
- 5 Water inlet
- 6 2 x water outlet

#### What is Pure Water?

Pure Water is water in its purest form, physically processed to remove the minerals that would otherwise lead to limescale spots and streaks. Such impurities are referred to as TDS (Total Dissolved Solids) and are measured in ppm (parts per million). The water is considered 100 % demineralised (pure) when its TDS is measured at 0 ppm, whilst the 180 ppm is considered as average water hardness.

#### Flow of water purification

The water enters the HydroPower RO via the water inlet (item 5).

The carbon/sediment combi pre-filter (item 1), which filters out the largest impurities and chlorine from the water and thus protects the membranes, sits before the membranes.

The 2 membrane filters (items 2, 3) remove up to 98% of the minerals from the water in the HydroPower RO.

The resin filter (item 4) sits after the membranes, which removes the last 2% of the minerals from the water in the HydroPower RO.

Pure water is discharged from the 2 water outlets (item 6) into a hose connected to a water fed pole for cleaning glass surfaces without chemicals.

The 4 filter cartridges (items 1 - 4) can be easily removed and replaced.

## 4.4 Commissioning

### CAUTION



**Slight injuries due to pressurized containers possible.**



- ▶ The 4 filter vessels are pressurized during operation.
- ▶ Never open a filter vessel during operation.
- ▶ Check if the hoses and tubes are water-tight and fit properly before commissioning the system.
- ▶ Use protective gloves.

To start the HydroPower RO, proceed as follows:

**ATTENTION: For new or conserved units, the resin filter is removed from the unit and must be inserted in step 14 !**

1. Connect the hoses. Do not forget the concentrate hose at the back of the R035C.
  2. Turn on the water supply
  3. Connect the power cord to the power supply.
  4. Turn on the main switch.
  5. Wait until the system is completely filled with water. You can check this by pressing the two yellow buttons on the front filters. As soon as water comes out here, the tanks are filled.
  6. Turn the yellow rotary switch to the upper position. The filtered pure water is delivered to the two water outlets.
- ✓ The HydroPower RO is now ready for use.



# HydroPower® R035C

## Commissioning

### 4.4.1. Commissioning of new or preserved R035C:

The resin filter is not used in new or preserved units, as it must not come into contact with the diaphragm care agent.

Before using the resin filter, the membrane maintenance agent must be completely rinsed out.

1. Start the appliance as described on page 18 and let it rinse out the membrane care agent for about 20 minutes.
  2. Switch off the R035C: turn the yellow switch to RO FLUSH.
  3. Then turn off the main switch.
  4. Disconnect the water supply.
  5. Insert the resin cartridge. Make sure that the orientation is correct, the arrow on the cartridge must point downwards, or the blue paper filter must point upwards!
  6. Press the resin cartridge a little firmly so that it sits well on the rubber seal.
  7. Screw the cover back on.
  8. Start the R035C with steps 1-6 on page 18.
- ✓ The HydroPower RO is now ready for use.



#### NOTE



You can adjust the amount of pure water produced by moving the yellow control knob between the left and upper position.

Middle position = Recommended working position, for optimum membrane life.

Below the middle position = Less pure water is produced.

Above the middle position = More pure water is produced. The load on membranes and resin increases more, which results in higher consumption costs.

## 5 Operation of the HydroPower R0

### 5.1 General information

Working with the HydroPower R0 is only permitted if the operating instructions have been read and understood.



#### **DANGER**



**Severe injuries and property damage due to the HydroPower R0 falling are possible.**



- ▶ Place the unit on a level surface only.
- ▶ Make sure the unit is stable and will not roll before operating the system.
- ▶ Wear safety shoes.



#### **CAUTION**



**Slight injuries due to pressurized containers possible.**



- ▶ The 4 filter vessels are pressurized during operation.
- ▶ Never open a filter vessel during operation.
- ▶ Check if the system is watertight before commissioning.
- ▶ Wear protective gloves.

## Operation

### 5.2 Cleaning surfaces with the HydroPower R0

The HydroPower R0 has two water outlets so that 2 people can work in parallel.

The water pressure is distributed over the 2 outlets and depends on the hose length or hose diameter used.

We recommend regulating the water pressure between the 2 hoses, especially with height differences, with a valve. For example the UNGER hose connection # 18330 incl. water switch or the UNGER HiFloControl # TMOOV, regulate the water quantity at the water fed pole.

Note that the right water connection receives more water from the membranes than the left. Therefore, long hoses or higher poles should be connected to the right water output.

Water output of the connectors



#### NOTE



The longer the hose from the water outlet to the water fed pole, the larger the diameter of the hose should be.

### 5.3 Interruption of work

If you need to interrupt your work with the HydroPower R0, proceed as follows:

- The pump control switches off automatically in case of negative pressure. As soon as the pressure rises back to working pressure, the pump starts up again automatically.
- You can therefore interrupt the water supply on the pole (e.g. with TMOOV HiFlo Control) and the pump stops. As soon as you open the water supply again, the pump starts again.
- If the pump does not start automatically, you can start it by pressing the RESET button on the side of the housing
- Alternatively, you can also switch off the device on the side with the main switch.



### 5.4 Switching off the HydroPower RO

To switch off the HydroPower RO after finishing the work, proceed as follows:

1. Switch off the unit with the main switch.
  2. Disconnect the power supply and the water supply.
  3. Open the pressure relief valve at the rear of the system to allow water to flow out of the tanks. Close it again when no more water flows out.
  4. Remove the hoses from the front connections.
- ✓ The HydroPower RO is switched off and can be transported.



## 6 Malfunctions

### 6.1 Procedure for accidents

Press the main switch located on the side of the HydroPower RO to turn off the system:

- In case of danger of injury,
- Risk of damage to the HydroPower RO.

In the event of an accident, take immediate action and call the local emergency number.

### 6.2 Procedure for malfunctions

During operation, the following faults may occur:

#### Water pressure too low

- ▶ The inlet pressure from the water pipe is too low to provide the desired filter performance. The pump switches off.
- ▶ Check whether the inlet hose is kinked or if there is too little pressure on the water pipe.
- ▶ As soon as the problem is solved, the pump should restart by itself.
- ▶ If the pump does not start by itself, press the blue RESET buttons on the side of the housing.



#### Overpressure

Overpressure can occur if the water pressure from the pipe is more than 6 bar.

To check the water pressure in the pipe, proceed as follows:

- ▶ The pressure gauge indicates the line pressure.
- ▶ As soon as the pump is switched on, the pressure increases by 4 bar. If the inlet pressure is too high, connect a water tap to the water inlet and regulate the pressure down.



# HydroPower® R035C

## Malfunctions

### Overheating

Always ensure that the HydroPower RO is well ventilated and is not too close to objects or walls which could cause air circulation prevent.

1. If the pump motor overheats, the HydroPower RO automatically.
2. Switch off the system at the main switch on the side.
3. Let the HydroPower RO cool down.
4. Start the HydroPower RO with the main switch.
5. If the pump does not start, press the blue RESET button on the side of the casing.
  - ▶ The pump motor is reset.
  - ▶ The HydroPower RO starts again.If the system does not start, let the HydroPower RO cool down even further.



## 7 Maintenance and servicing

### 7.1 General information



#### **DANGER**



#### **Electric shock possible through live parts.**

- ▶ Maintenance on the electrical components of the system should only be carried out by employees of Unger Germany GmbH or their authorized specialist dealers / technicians.



#### **CAUTION**



#### **Burns due to hot surfaces possible.**

- ▶ The housing of the pump motor can become hot during operation. Allow the system to cool down sufficiently before touching components marked with this symbol.
- ▶ Wear protective gloves.



#### **ATTENTION**

#### **Damage caused by improper cleaning of the HydroPower RO possible.**

- ▶ Do not use aggressive cleaning agents and / or solvents.
- ▶ Observe the safety instructions for the cleaning and solvent of the respective manufacturer.

#### **ATTENTION**

#### **Material damage due to insufficient maintenance possible.**

- ▶ Before each use, perform a visual inspection of the power cord for damage. If you notice any damage, contact your distributor.



## Maintenance and servicing

### Membrane protection during storage

If the unit will not be in use for more than 7 days, the membrane must be protected according to the storage instructions, see chapter „7.2.4 Membrane protection.“

If the membrane is not regularly flushed or protected with the UNGER membrane care agent, there is a risk of blockage and thus a strong performance limitation or damage.

### Frost protection

Never store the HydroPower RO below 5°C. When not in use for a longer period of time, drain the water from the HydroPower RO. Open the pressure relief valve on the back of the HydroPower RO until no water leaks out.

## 7.2 Maintenance and maintenance plan

Check the condition of the R035C filter regularly to ensure long life.

### 7.2.1 Daily inspection

Observe the indication on the display. It provides information about the filter performance or the filtered water quality. Press the yellow „on“ button to switch on.

- RO = shows the TDS value of the water behind the membranes (#2+#3).
  - ▶ The membranes should have a performance level of approx. 95-98%.
  - ▶ If the output value deviates higher from the input water value, the membranes should be replaced. Example: Water input value from the water pipe 400ppm - then the „RO“ value in the display should not be higher than 20 ppm (95%).
  - ▶ You can determine the input water value e.g. with the separately available hand-held TDS-meter #ROTDS
- DI = shows the TDS value behind the resin filter.
  - ▶ If this value is at or above 10, the resin filter must be replaced.

### 7.2.2 Monthly examination

- Replace the comb-prefilter regularly. It protects the membranes from chlorine. From a water flow of approx. 70,000l with a chlorine content of 2ppm, the carbon filter is used up and can no longer guarantee this protection.
  - ▶ Observe the water meter at the front of the housing.
  - ▶ A water flow of 70.000l is reached after about 4 weeks if you work with the RO-filter 5 days a week for 5 hours at a time, for example.

### 7.2.3 Quarterly examination

- Grease the o-rings in each of the four top caps with a non-silicone-based grease.
- Lubricate the water connections with lubricant or oil, such as WD 40.



RO TDS  
(sold separately)

### 7.2.4 Membrane protection



#### CAUTION



**Irritation to eyes, skin and respiratory tract through membrane care possible.**



- ▶ Avoid any contact and swallowing of the membrane care fluid.
- ▶ In case of contact with eyes, remove contact lenses and rinse immediately with plenty of water.
- ▶ Keep the membrane care product sealed and inaccessible to children.
- ▶ Wear protective gloves and goggles.



The membrane achieves its optimal life with regular water flow or flushing.

If the HydroPower RO is not in use for an extended period of time (longer than 7 days), the membrane must be protected against blockage.

For this purpose, there is the UNGER Membrane Care Agent (Order No. 15436). You need one bottle (1l) for each membrane. This preserves the current state of the membrane and prevents reduced performance and/or damage after sitting for a longer period of time. Alternatively, you can run the unit once a week for approx. 30 minutes to rinse the membranes.

#### To protect the membrane, proceed as follows:

1. Switch off the HydroPower RO and disconnect the power supply.
  2. Drain the water from the HydroPower RO.  
Unscrew all filter top caps and open the pressure relief valve on the back of the HydroPower RO until no more water leaks out.
  3. Close the pressure relief valve and screw the yellow cap onto the concentrate outlet.
  4. Remove the pre-filter and resin filter cartridges and store them protected from dust and dirt.
  5. Pour one bottle of membrane care liquid (1l) into each of the membrane tanks.
  6. Fill all tanks (#1 pre-filter + both membranes #2, #3) with tap water until all three tanks have filled just below the top edge. Tank #4 can remain without water.
  7. Close all four tanks.
- ✓ The membranes are protected and the HydroPower RO can be stored.



#### Re-commissioning

1. Unscrew all 4 filter top caps.
2. Drain the water: Unscrew the yellow cap and assemble the concentrate hose.  
Now open the pressure relief valve at the rear.
3. Insert the filters. Pay attention to the correct position.
4. Screw the top-caps back on and start the system.
5. The membrane care liquid is automatically rinsed out. Allow the system to flush for approximately 20 minutes.
6. Switch the system off again at the main switch and insert the pre-filter and resin filter.

# Replacing filter cartridges

## 7.3 Repair and replacement of parts

You will find a spare part list on the Unger website [www.ungerglobal.com/RO](http://www.ungerglobal.com/RO) with parts that you can change yourself.

For any further repairs, please contact your dealer.

### 7.3.1 Replacing filter cartridges



#### CAUTION



#### Irritation to the eyes, skin and respiratory tract possible.



- ▶ In the filter cartridges, there is resin for the final demineralization of the water.

- ▶ Avoid any contact with the resin when working on the filter cartridges.

- ▶ Wear protective gloves and goggles.



- ▶ In case of contact with eyes, remove contact lenses and rinse immediately with plenty of water.

- ▶ Wash hands after finishing work.

If the display shows a too high ppm value for RO or a value of 10 ppm for DI, the corresponding filter cartridge must be replaced (see point 7.2.1). The combi-pre-filter should also be changed regularly to ensure membrane protection, especially against chlorine (see point 7.2.2). Changing all 4 filter cartridges is quick and easy.

To replace the filter cartridges, proceed as follows :

1. Switch off the HydroPower RO and disconnect the power supply.
2. Drain the water from the HydroPower RO.  
Open the pressure relief valve on the back of the HydroPower RO until no water leaks out.
3. Press the two push buttons on the front two filters.
4. Rotate the filter cartridge top cap counter - clockwise.
5. Pull out the filter cartridge.



Combi pre-filter



Membranes



Resin filter

# HydroPower® R035C

## Replacing filter cartridges

### Inserting the filter cartridges

2. Insert a new filter cartridge into the HydroPower RO the right way round.

#### Carbon sediment combi prefilter (#1)



▶ Here it does not matter how the filter is inserted.



#### RO Membranes (#2+#3)



- ▶ The 2 RO-membranes have an imprint indicating the flow direction, the **arrow must point upwards**.
- ▶ The **rubber seal** must always be at the **top**

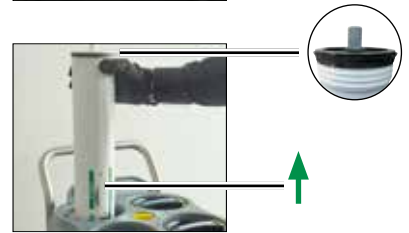

#### DI-resin filter (#4)



- ▶ The **sealing cap must be replaced** every time the filter is changed
- ▶ To do this, remove the old sealing cap and place the new one on the guide socket in the hopper. (see illustrations). Press down until it sits flat.
- ▶ Insert the new filter the right way round (arrow down, paper filter up and press carefully on the sealing cap. If it is the wrong way round, water cannot flow through and backwater will occur.

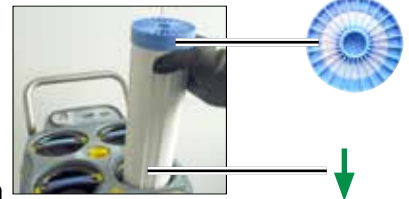

- Replace the top cap and turn it clockwise.
  - ▶ The top cap locks with a „click“ and must stay in this position (see picture). Do not turn it further !
- Proceed the same for all other filter cartridges.
- ✓ The filter cartridges are replaced.



### NOTE



The covers are marked with different shades of blue. The dark blue belongs to the front left vessel for the carbon/sediment combi pre-filter, the medium blue to the rear vessels for the membranes and the light blue to the front right vessel for the resin filter.

# Switching off the device

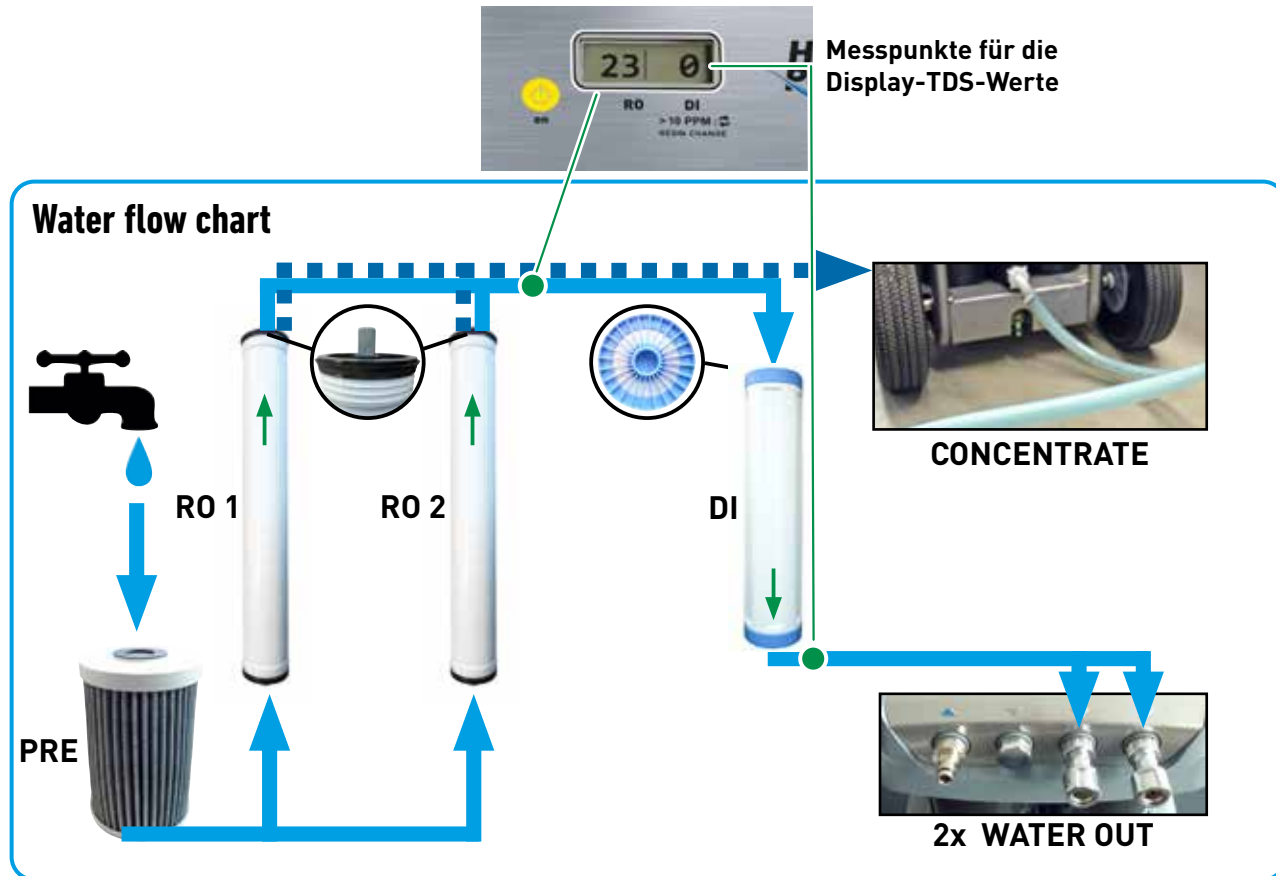

ENGLISH

## 8 Switching off the device

### 8.1 Disassembly and storage



#### DANGER



**Electric shock and burns due to live parts possible.**

- ▶ Maintenance on the electrical components of the system may only be carried out by employees of Unger Germany GmbH or their authorized specialist dealers / technicians.



#### CAUTION



**Burns due to hot surfaces possible.**

- ▶ The housing of the pump motor can become hot during operation. Allow the system to cool down sufficiently before touching components marked with this symbol.
- ▶ Wear protective gloves.



#### ATTENTION

**Material damage due to improper storage.**

- ▶ Clean the system from dirt build up.
- ▶ Use only membrane care products from Unger Germany GmbH.
- ▶ Never store the HydroPower RO below 5°C.

#### NOTE



When storing for an extended period of time (e.g. winter, holidays), leave the filters in the HydroPower RO, where they are optimally protected against weathering.

To prepare the HydroPower RO for storage, proceed as described in chapter 7.2.4.

## 8.2 Recycling

Properly recycle all materials that can be recycled to help protect our environment.

The packaging material is to be separated. It consists of foam, wood, plastic and corrugate cardboard and is to be recycled individually according to recycling standards.

## 8.3 Disposal of waste

If the HydroPower RO has reached the end of its life cycle, it must be disposed safely and professionally, particularly with regard to parts or substances harmful to the environment.

Before disposing of the HydroPower RO, remove all 4 filter cartridges and dispose of them in accordance with the national regulations at your disposal company.

In order to avoid danger to the environment, an approved specialist company is to be commissioned to dispose of the filter cartridges. The local authority can provide information on this.

Return the HydroPower RO for disposal to Unger Germany GmbH.

# Notes



The RO M (R035C) is compliant with the provisions of the Machinery Directive 2006/42 / EC and the Directive on Electromagnetic Compatibility 2014/30 / EU.

The protection objectives of Directive 2014/35 / EU on electrical equipment have been upheld.

Applied harmonized standards:

- |                   |   |
|-------------------|---|
| EN ISO 12100:2011 | Security of machines -<br>General design principles - risk assessment<br>and risk reduction |
| EN 60204-1:2010   | Electrical equipment of machines -<br>General requirements                                  |

This is confirmed by the EC Declaration of Conformity.

Solingen, 02.03.2020

Kai Hirsch  
Director Advanced Technologies  
Unger Germany GmbH



## NOTE



The system is only intended for professional use and operation at 230 V / 50 Hz in an industrial low-voltage network.

**Unger Germany GmbH**  
Piepersberg 44  
D-42653 Solingen  
GERMANY  
Fon +49 (0)212 / 22 07-0  
Fax +49 (0)212 / 22 07-222  
ungereurope@ungerglobal.com

**Unger UK Ltd.**  
F1 Deansgate, 62-70 Tettenhall Road  
Wolverhampton, WV1 4TH  
UNITED KINGDOM  
Fon +44 (0)1902 306 633  
Fax +44 (0)1902 306 644  
ungeruk@ungerglobal.com

**Unger Enterprises LLC**  
425 Asylum Street  
Bridgeport, CT 06610  
USA  
Tel.: (1) 800.431.2324  
Fax: (1) 800.367.1988  
unger@ungerglobal.com

[www.ungerglobal.com](http://www.ungerglobal.com)

